

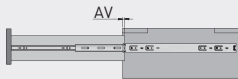

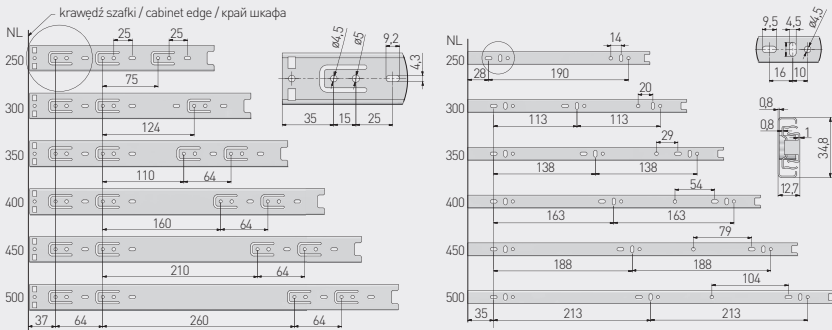

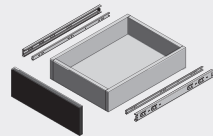



Prowadnica kulkowa H35
Ball bearing slide H35
Шариковая направляющая H35



NL = długość nominalna prowadnicy
nominal slide length
номинальная длина направляющей
AV = strata wysuwu
extension loss
потеря на выдвигении



Uwagi montażowe: dla prawidłowego działania szuflady jej szerokość nie może przekraczać długości nominalnej prowadnicy.
Mounting information: for proper drawer operation, the width of the drawer can not exceed the nominal slide length.
Техническое примечание: Ширина ящика не должна превышать длину направляющей.

		 L mm	 AV mm		 kg			
PK-0H35-2500		250	4	pełny full полное	25	ocynk galvanized гальваника	stal steel сталь	30
PK-0-H35-3000		300						20
PK-0-H35-3500		350						
PK-0-H35-4000		400						
PK-0-H35-4500		450						
PK-0-H35-5000		500						

